



ASI2600 Manual

Revision 1.0

Dec,2019

All materials related to this publication are subject to change without notice and its copyright totally belongs to Suzhou ZWO CO.,LTD.

Please download the latest version from our Official website.



Table of Contents

ASI2600 Manual	1
1. Instruction	3
2. What's in the box?	4
3. Camera technical specifications	5
4. QE Graph & Read Noise	6
5. Getting to know your camera	8
5.1 External View	8
5.2 Power Consumption	9
5.3 DDR Buffer	9
5.4 Cooling System	10
5.5 Back Focus Distance	10
5.6 Protective Window	11
5.7 Analog to Digital Converter (ADC)	11
5.8 Binning	11
5.9 Tilt Adjustment	12
6. How to use your camera	13
7. Cleaning	15
8. Mechanical drawing	17
9. Servicing	18
10. Warranty	18

1. Instruction

Congratulations and thank you for buying one of our ASI Cameras ! This manual will give you a brief introduction to your ASI camera. Please take the time to read it thoroughly and if you have any other questions, please feel free to contact us at info@zwoptical.com.

Welcome to join ZWO FB and User Forum below!

Facebook : <https://www.facebook.com/ZwoDesignAstronomyCameras>

User Forum: <https://bbs.astronomy-imaging-camera.com/>

ASI2600 Camera is specifically designed for astronomical photography. It is not only suitable for DSO imaging but also for Planetary imaging You will be impressed by its superior performance and wide use!

Model	Mono/Color	(TEC) Cooling	DDR3 Buffer	Sensor
ASI2600MC Pro	Color	Two Stage	256MB	SONY IMX571

For software installation instructions and other technical information, please refer to our official website <http://zwoasi.com/>

2. What's in the box?

ASI2600MC Pro camera

What is in the box?



Camera bag



Camera body



M48-M42 adapter



Quick guide



USB 3.0 cable
(2m)



M42-M42 21mm
extender



M42-M48 16.5mm
extender



2" cover



Hexagon wrench



USB 2.0 cable
(0.5m) X2

3. Camera technical specifications

Sensor	SONY IMX571 CMOS
Diagonal	28.3mm
Resolution	26 Mega Pixels 6248*4176
Pixel Size	3.76 μ m
Image area	23.5*17.5mm
Max FPS at full resolution	3.51FPS
Shutter	Rolling shutter
Exposure Range	32 μ s-2000s
Read Noise	1.0-3.3e
QE peak	Above 80%
Full well	50ke
ADC	16bit
DDR3 buffer	256MB
Interface	USB3.0/USB2.0
Adapters	M42*0.75
Protect window	IR CUT
Dimensions	90mm
Weight	0.7kg
Back Focus Distance	17.5mm
Cooling:	Regulated Two Stage TEC
Delta T	35 °C below ambient
Cooling Power consumption	12V at 3A Max
Supported OS	Windows, Linux & Mac OSX

4. QE Graph & Read Noise

QE and Read noise are the most important parts to measure the performance of a camera. Higher QE and Lower read noise are needed to improve the SNR of an image. For the 2600 Sensor, the peak value for QE is around 80%.

Read noise includes pixel diode noise, circuit noise and ADC quantization error noise. The lower the better.

As you can see, the Read Noise of the ASI2600 camera is extremely low when compared with traditional CCD cameras. In addition, it is with Built-in HCG mode, which can effectively reduce read noise at high gain and keep the same wide dynamic range for this camera as at low gain.

Depending on your target, you can set the gain lower for higher dynamic range (longer exposure) or set the gain higher for lower noise (such as short exposure or lucky imaging).

Read noise, full well, gain and dynamic range for ASI2600

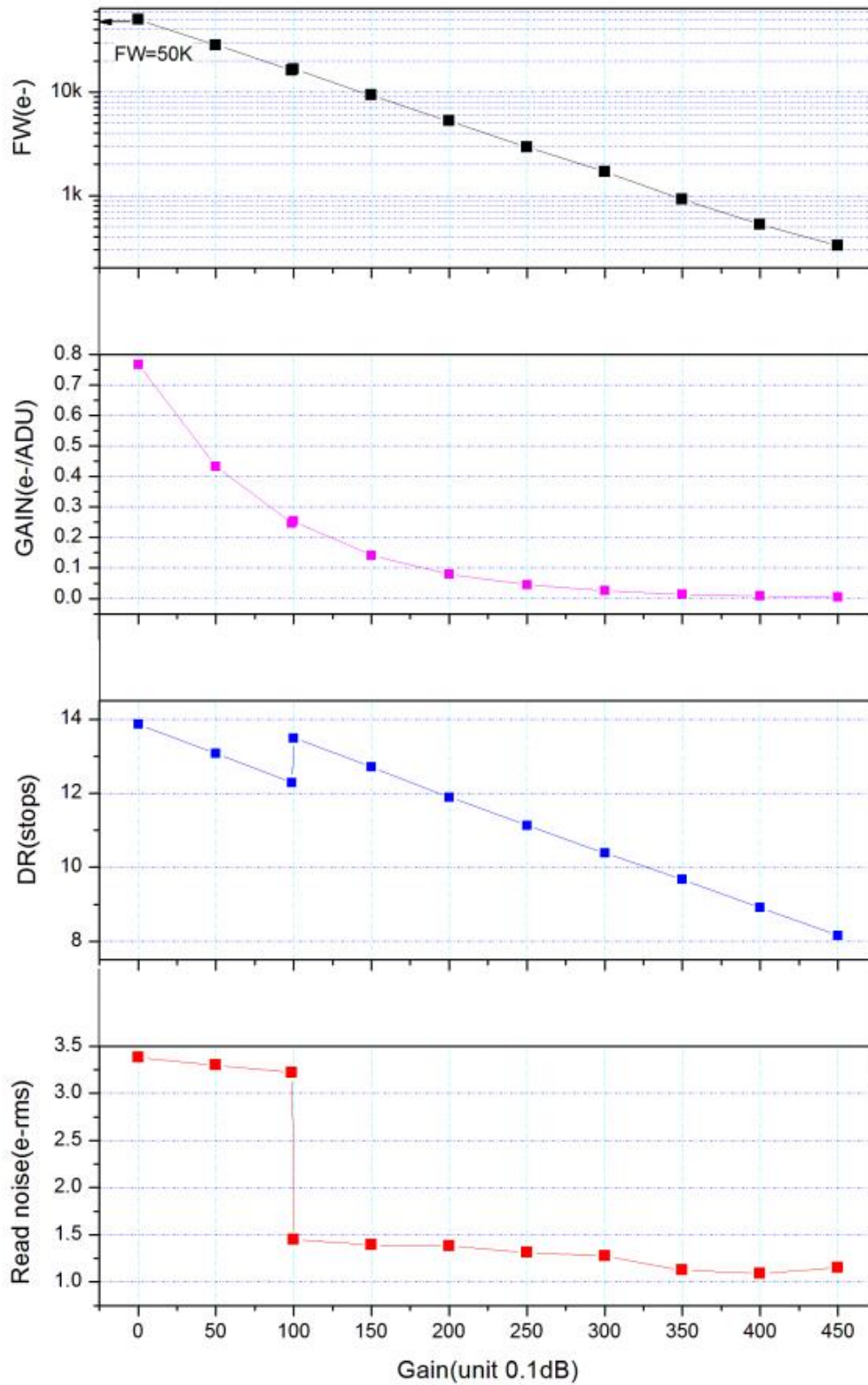

5. Getting to know your camera

5.1 External View



1. Protective Window, IR CUT, D60*2mm
2. Tilt adjustment ring, M42*0.75 thread, thickness 5mm, can be removed
3. Radiator
4. USB2.0Hub
5. USB3.0/USB2.0 Interface
6. Cooling power supply DC power port: size 5.5 * 2.1mm, positive inside and negative outside, 12V@3A power is recommended.
7. Ultra-quiet magnetic levitation fan, will rotate only when the cooling is on.

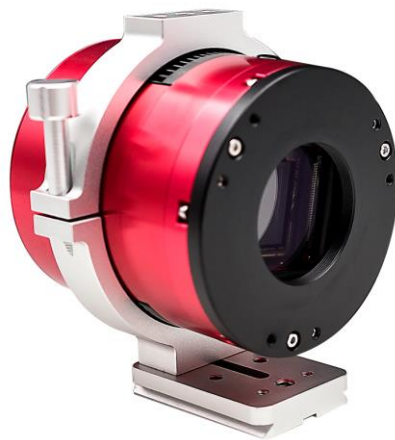

The camera can be placed on a holder ring for Cooled cameras with a 1/4" thread under the ring.

5.2 Power Consumption

ASI2600 camera is with low power consumption, max at 4.7W USB3.0 cable is recommended for power supply.

Recommended power supply for cooling: 12V @ 3A DC adapter (5.5×2.1mm, center pole positive). Also suitable: lithium battery with 9-15V.

Here is the ASI2600 cooling efficiency graph.

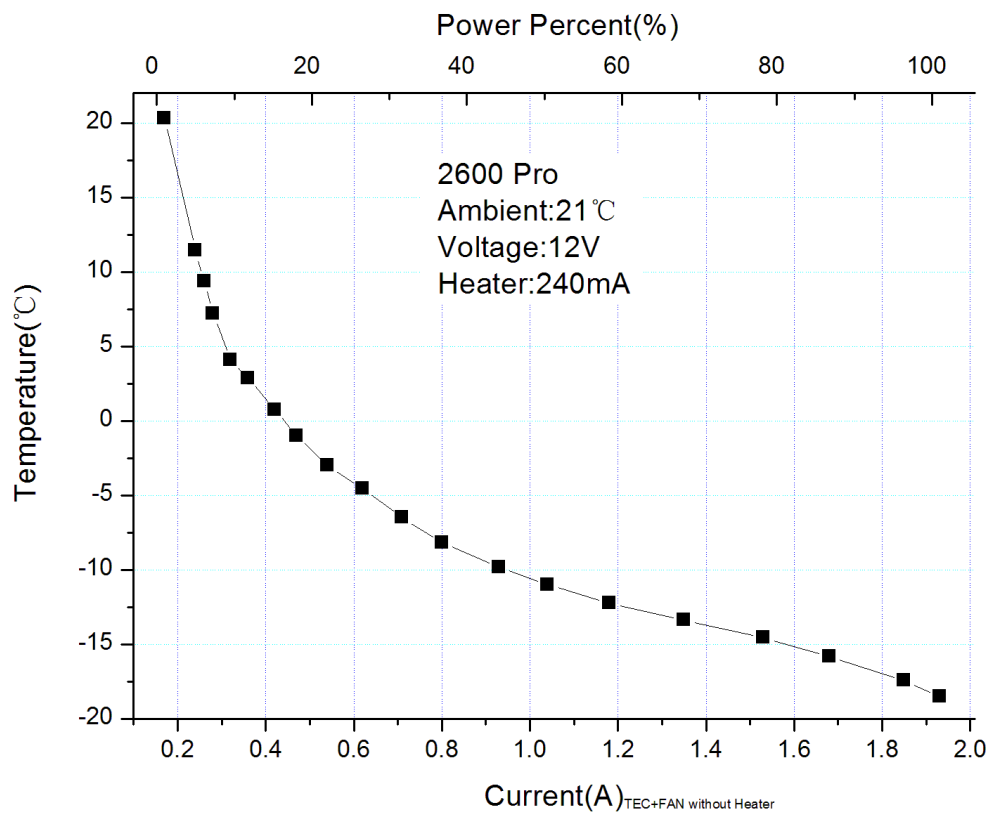

5.3 DDR Buffer

The ASI2600 Pro camera includes a 256MB DDR3 memory buffer to ensure the stability of data transmission. Additionally, the use of a memory buffer minimizes amp-glow, which is caused by the slow transfer speeds.

5.4 Cooling System

The Cooling system of ASI2600 Pro camera can precisely control the sensor temperature. Unlike traditional CCD, the ASI2600 camera has ultra-low readout noise, efficient cooling, and adjustable gain. There is no need to use ultra-long exposures to shoot targets, which significantly reduces the requirements for the photography system as well as the guide system. However, if you use short exposures (for example, less than 100ms), the effect of cooling on the image will be little. Cooling system can be set to a minimum temperature of 35 °C below ambient temperature.

Here's the dark current curve of ASI2600 sensor between -20 °C and 30 °C

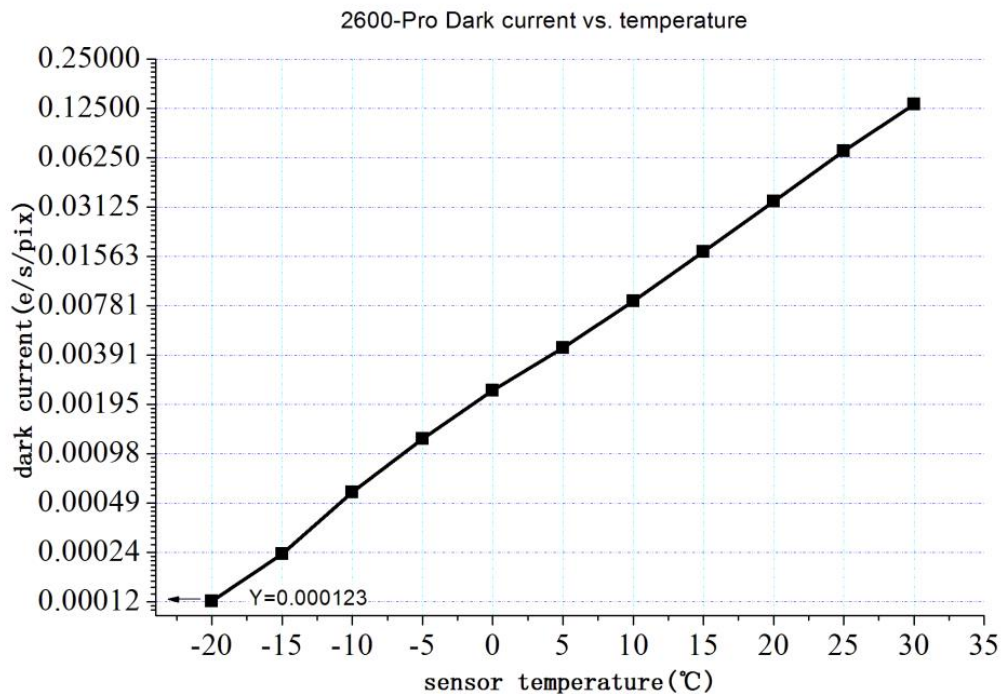

5.5 Back Focus Distance

The female flange to the sensor is 17.5mm. You can reach 55mm back focus distance with the 21mm and 16.5mm extender included in the camera package.

5.6 Protective Window

There is a protective window-IR CUT filter in front of the ASI2600 camera sensor, with 60mm diameter and 2mm thickness.

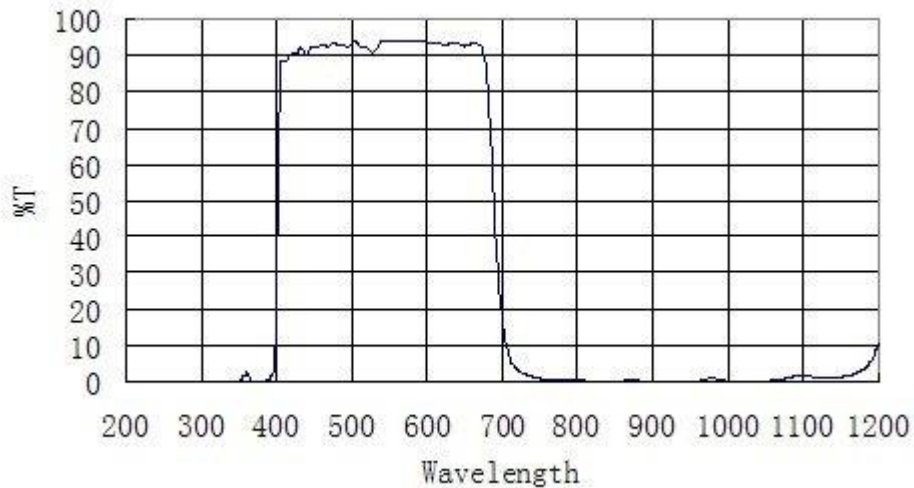

5.7 Analog to Digital Converter (ADC)

The ASI2600 camera has a built-in 16bit ADC. 12bit ADC mode for output will be used when we do hardware Bin, this camera also supports custom ROI partial readout mode, with faster frame rate at small ROI resolutions.

Please see below attached different frame rates under different resolutions on USB3.0 and USB2.0 of ASI2600 in 16bit mode.

Resolution	16Bit ADC	
	USB2.0	USB3.0
6248*4176	0.83fps	3.51fps
4096*3072	1.72fps	4.75fps
3840*2160	2.61fps	6.71fps
1920*1080	10.43fps	13.13fps
1280*720	19.29fps	19.29fps
640*480	28.06fps	28.06fps
320*240	51.44fps	51.44fps

5.8 Binning

The ASI2600 camera supports bin2, bin3, bin4 software Binning mode and hardware bin2, bin3,

the best advantage of hardware binning is the faster frame rates. If you don't care about speed, we suggest you use software binning.

5.9 Tilt Adjustment

There are 3 sets of screws that can be used to tilt the sensor, to make it same with the primary mirror of Newtonian, two screws per set for screw in /out.



You can refer to below:

1. Take a starred image with the camera, you will easily find out the tilt part in the image through the software, and then adjust one or more sets of flange adjustment screws on the camera corresponding to the image.
2. Take another image after the sensor tilt adjustment, compare the new image with the previous one in the software. If the tilt issue is reduced, that means the adjustment is correct. Otherwise, the adjustment is wrong.
3. Repeat step 2 until the stars in all corners are perfect.

6. How to use your camera

Using an adapter, the ASI2600 camera can be connected to a telescope, or a camera lens. Most of the adapters are already included in the package, and the rest can be purchased directly from our official website below.

<https://astronomy-imaging-camera.com/>

Canon lens Connection Diagram:

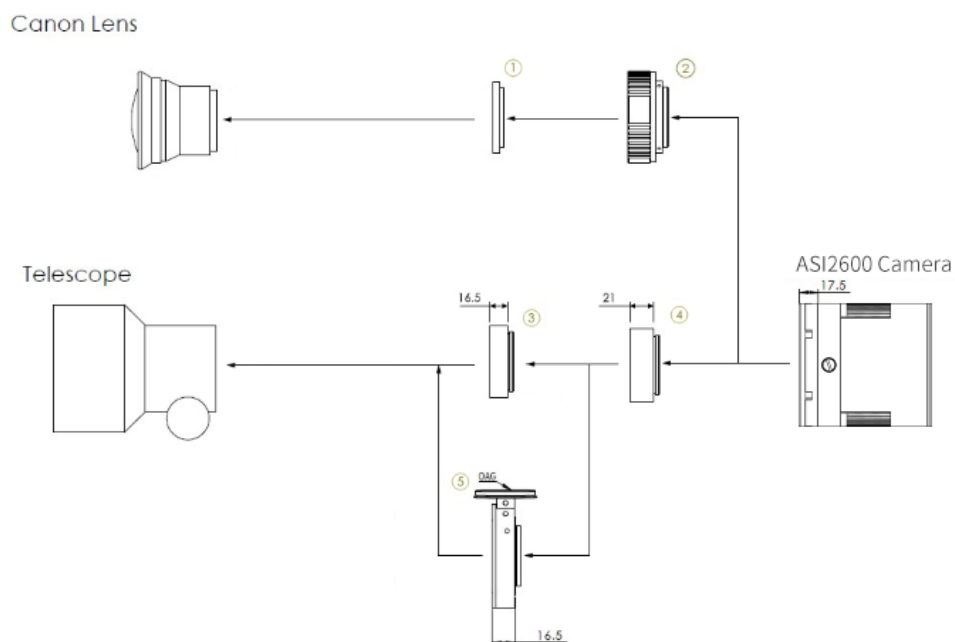

1. 2" filters (optional)
2. EOS-T2/Nikon-T2 adapter
3. M42-M48 16.5mm extender
4. M42-M42 21mm extender
5. 16.5mm OAG





7. Cleaning

The camera is sealed and comes with an AR protect window to protect the sensor from dusts and humidity. We don't recommend customers to open the camera for cleaning. Otherwise, chamber of the sensor can get wet which will cause the sensor getting dew when do cooling in the future.

To see the dusts, you just need to set up your telescope and point it to a bright place. A Barlow is required to see these dusts clearly. Then attach the camera and adjust the exposure to make sure not overly exposed. You can see an image like below if it's dirty.

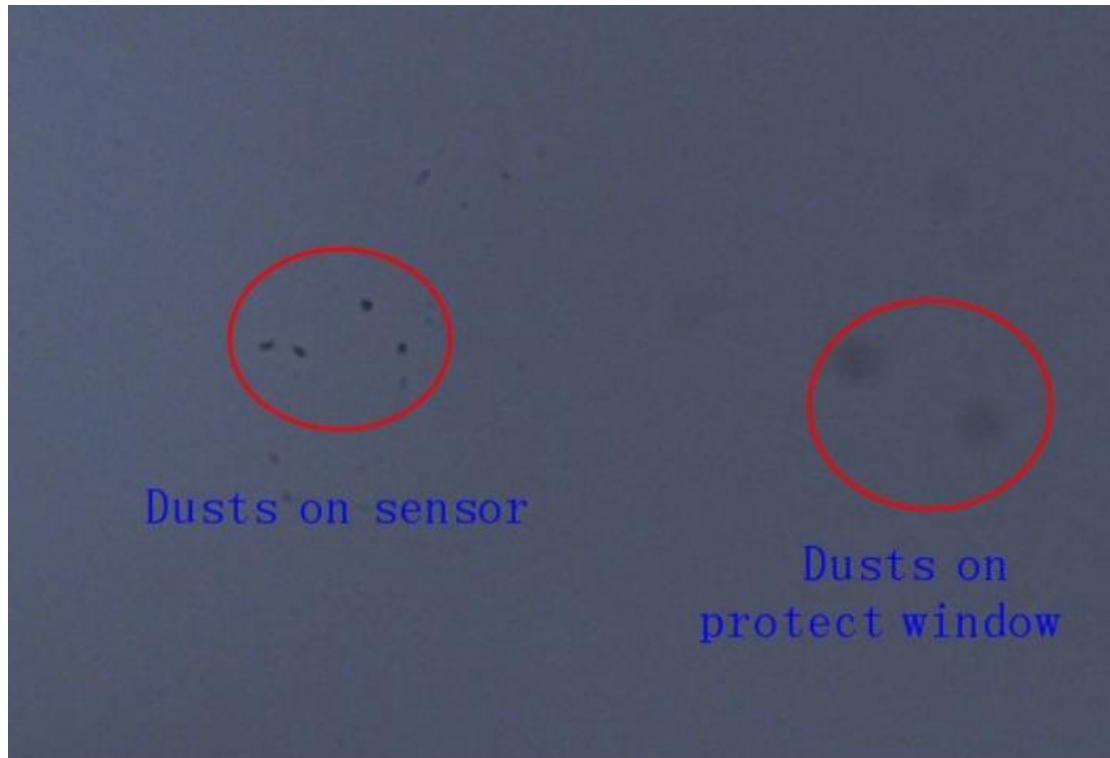

The big dim spot on the image (right side) are the shadows of dust on the protect window.
The very small but very dark spot on the image (at left) are the shadows of the dusts on the sensor.
If above situation occurs, it is recommended that the dust on the sensor surface be blew off with air pump, and the remaining dust is suggested to be removed by the software after the flat field is taken.

We have very detailed instruction on our website:

<https://astronomy-imaging-camera.com/manuals/>

8. Mechanical drawing

ASI2600MC Pro

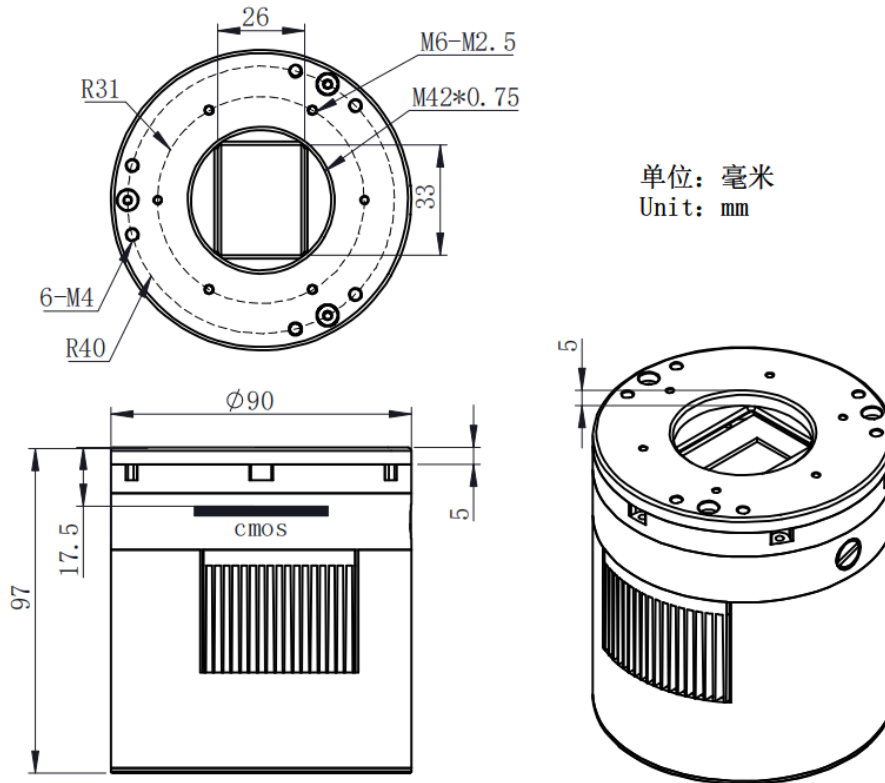

9. Servicing

For software upgrades, please refer to “Support-manual and software” on our official website.

<https://astronomy-imaging-camera.com/>

Repairs and servicing are available by emailing info@zwoptical.com

For customers who bought the camera from your local dealer, dealer is responsible for the customer service.

10. Warranty

We provide 2-year warranty for our products. We offer repair service or replacement for free if the camera doesn't work within warranty period.

After the warranty period, we continue to provide repair support and service on a charged basis.

This warranty does not apply to damage that occurred as a result of abuse or misuse, or caused by a fall or any other transportation failures after purchase.

Customer must pay for shipping when shipping the camera back for repair or replacement.