



# **ASI585 Manual**

Revision 1.0

Aug, 2022

All materials related to this publication are subject to change without notice and its copyright totally belongs to Suzhou ZWO CO.,LTD.

Please download the latest version from our Official website.



## Table of Contents

ASI585 Manual.....	1
1. Instruction.....	3
2. What's in the box? .....	4
3. Camera technical specifications.....	5
4. QE graph & Read noise .....	6
5. No amp glow.....	8
6. Getting to know your camera.....	9
6.1 External View.....	9
6.2 Structural dimension diagram .....	10
6.3 Power consumption.....	10
6.4 Protect window .....	10
6.5 Analog to Digital Converter (ADC).....	11
6.6 Binning.....	11
7. How to use your camera.....	12
Notice for use.....	13
8. Cleaning .....	14
9. Warranty .....	15
10. Servicing .....	16

# 1. Instruction

Congratulations and thank you for buying one of our ASI Cameras! This manual will give you a brief introduction to your ASI camera. Please take the time to read it thoroughly and if you have any other questions, please feel free to submit it on the ZWO support site:

<https://support.astronomy-imaging-camera.com/>

The ASI585MC is one of the latest color planetary cameras released by ZWO in 2022. Packed with Sony sensor IMX585, this camera has some very great highlights, including a large sensor format of 1/1.2", a high resolution of 3840\*2160, and a surprisingly amazing characteristic of zero amp glow. With many parameters in common, the ASI585MC can be regarded as the upgraded version of ASI485MC.

<b>Model</b>	<b>Mono/Color</b>	<b>Sensor</b>
<b>ASI585MC</b>	Color	SONY IMX585

For software installation instructions and other technical information, please refer to our official website <https://astronomy-imaging-camera.com/>

## 2. What's in the box?

ASI585MC



### 3. Camera technical specifications

Sensor	SONY IMX585 CMOS
Format	1/1.2"
Diagonal	12.84mm
Resolution	8.29 Mega Pixel, 3840*2160
Pixel size	2.9 $\mu$ m
Sensor size	11.2mm * 6.3mm
Max fps	46.9
Shutter	Rolling shutter
Exposure range	32 $\mu$ s-2000s
Readout noise	0.8 ~ 12e (2.4e@15db gain)
QE peak	91%
Full well	47ke
ADC	12bit
USB interface	USB 3.0
Adapters	2"/M42X0.75
Protect window	AR D32*2mm
Dimension	62mm
Weight	126g
Back focus length	6.5mm/17.5mm
Working temperature	-5°C~50°C
Working relative humidity	20% ~ 80%
Supported OS	Windows, Linux & Mac OSX

## 4. QE graph & Read noise

QE and Read noise are the most important parts to measure the performance of a camera. Higher QE and Lower read noise are needed to improve the SNR of an image.

The following figure shows the QE curve of ASI585. According to our measurement, the QE peak of ASI585 is 91%.

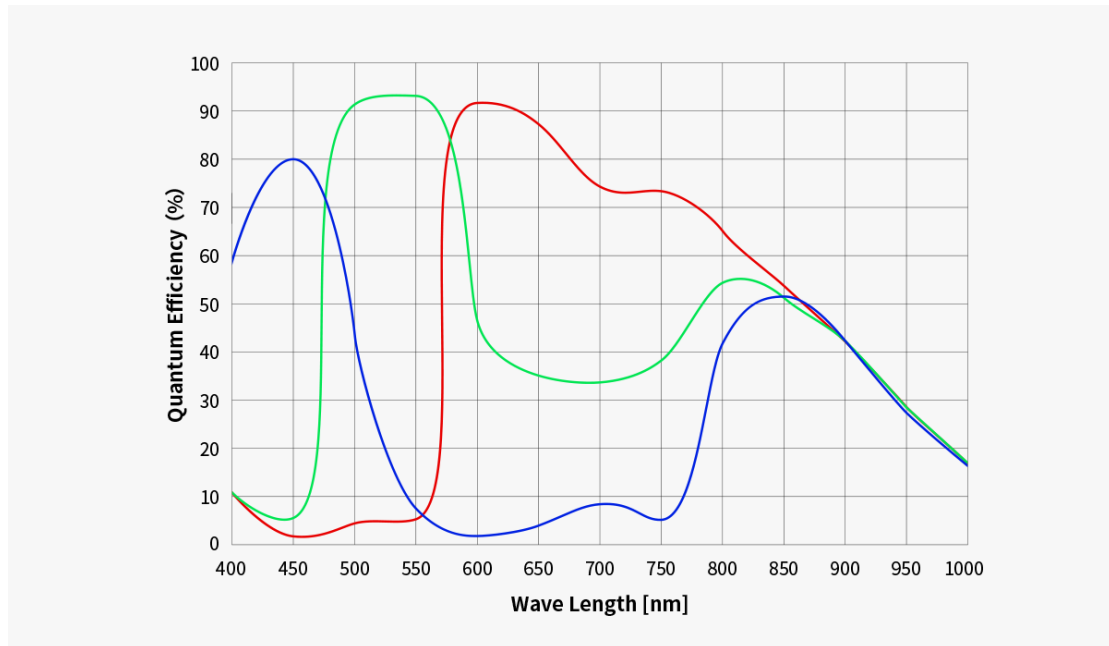

As you can see from the camera performance graph, the readout noise of ASI585 is very low. The built-in HCG mode can even more reduce readout noise at high gain and keep the same wide dynamic range for this camera as at low gain. When you set gain at 252, the HCG mode will be automatically turned on. Readout noise in this case can be as low as 1.5e while the dynamic range can still be close to 11bit.

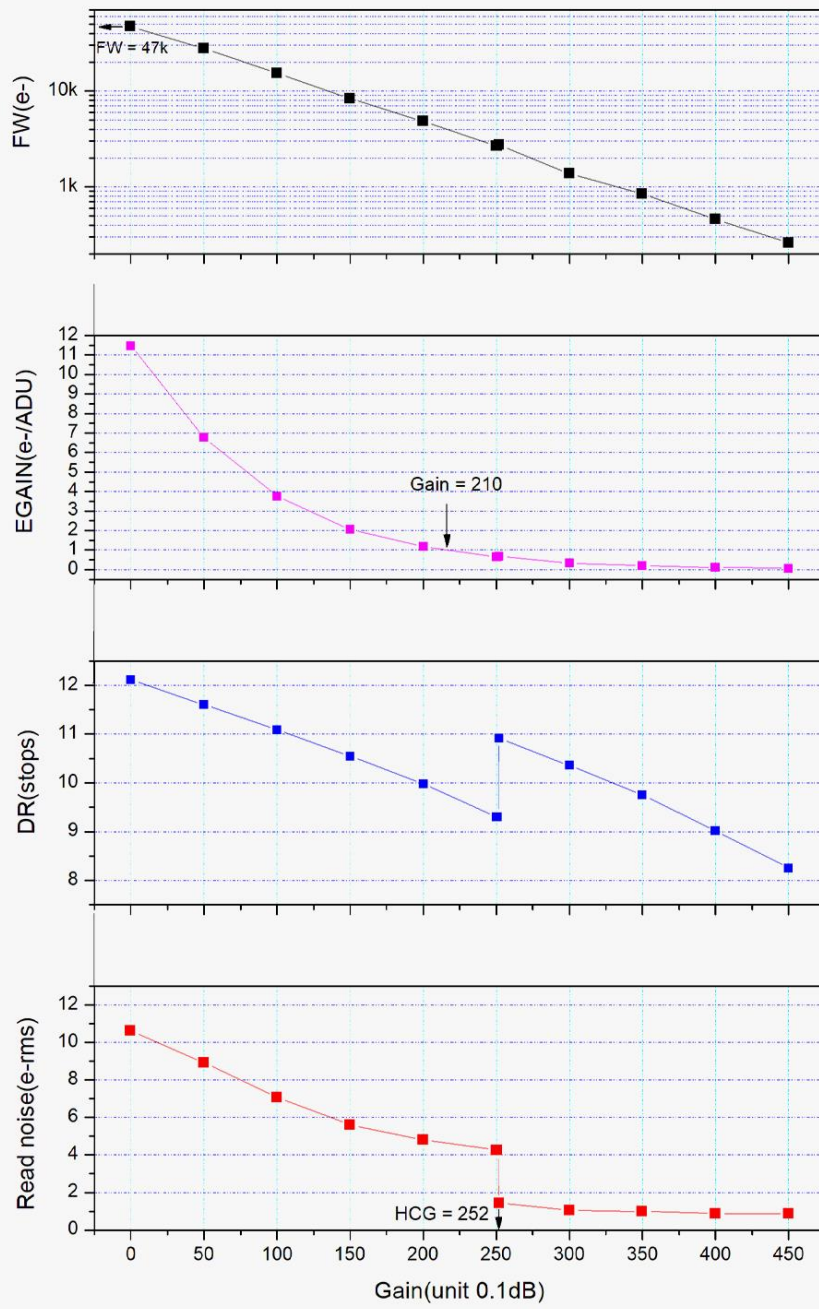

## 5. No amp glow

ASI585 exhibits zero amp glow, no matter how long the exposure and how high the gain value is. Since it is implemented directly at the hardware level, it does not require software control.

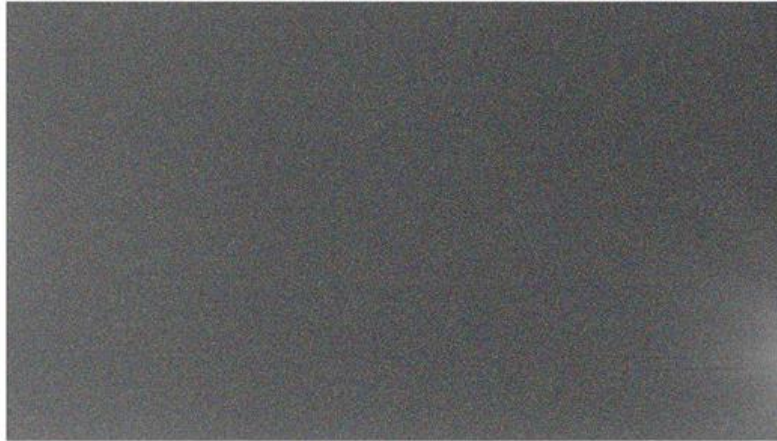

ASI485MC 300.0s

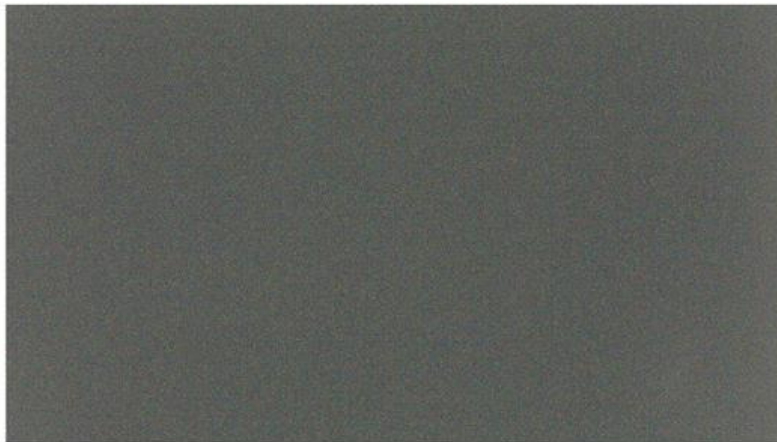

ASI585MC 300.0s



## 6. Getting to know your camera

### 6.1 External View



- ① USB 3.0 & USB 2.0 Input
- ② ST4 Guide port
- ③ AR Protective window D32\*2mm
- ④ 1/4" screw: allowing you mount the camera to tripod.

## 6.2 Structural dimension diagram

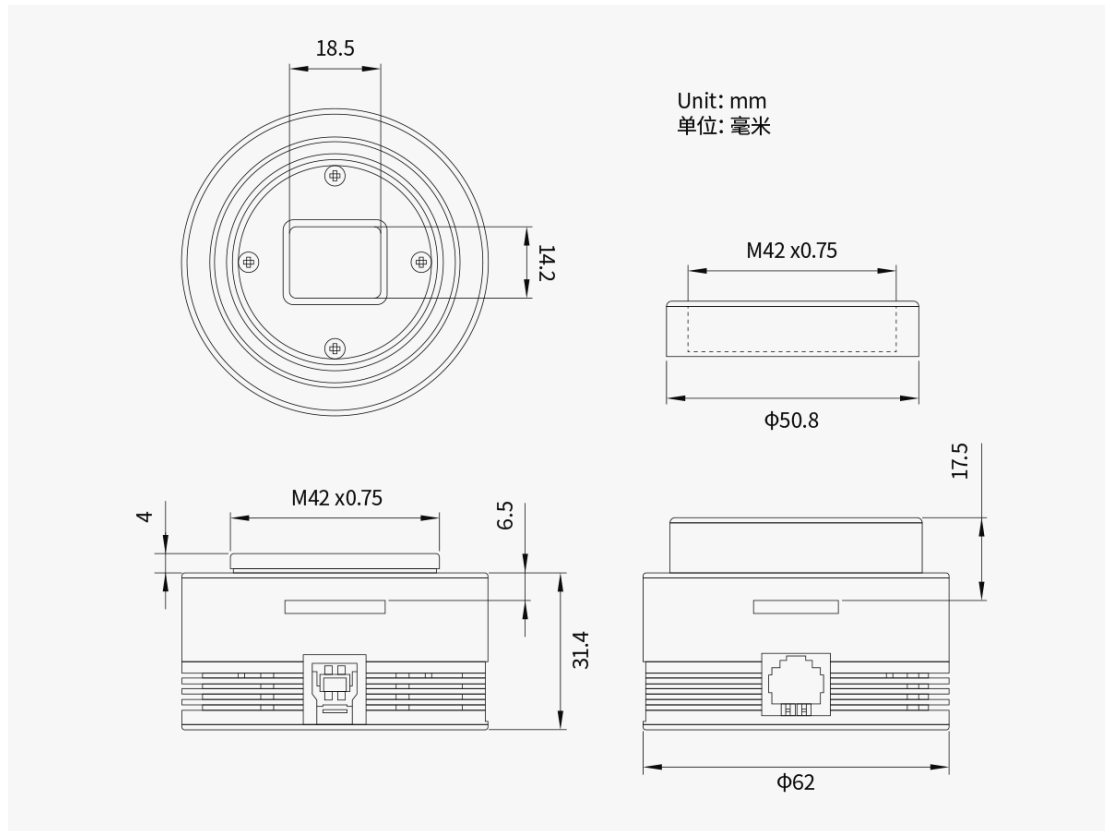

## 6.3 Power consumption

ASI585 camera is built with low power consumption, max at 2.86W with USB power supply.

## 6.4 Protect window

There is a protective window AR filter in front of the ASI585 camera sensor, with 32mm diameter and 2mm thickness.

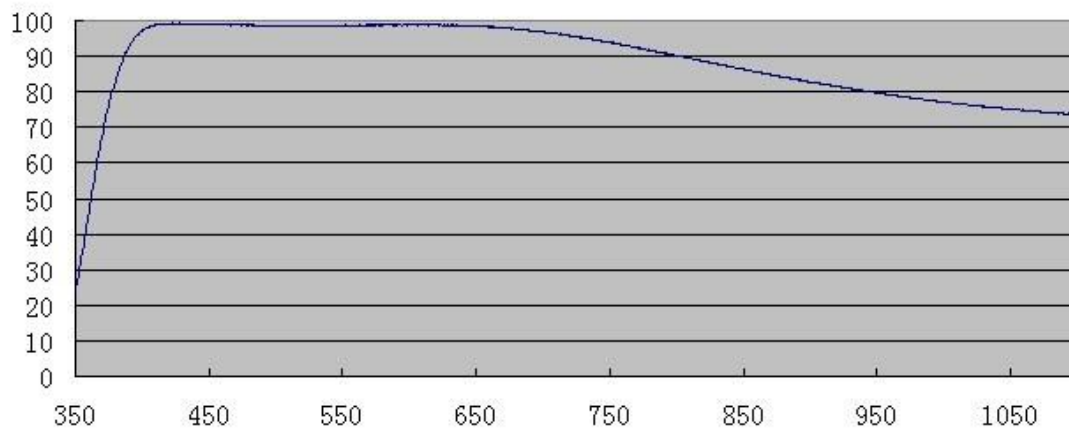

## 6.5 Analog to Digital Converter (ADC)

The ASI585 camera records in 12bit ADC and 10bit ADC. You can image at a faster fps rate if you use 10bit ADC (high speed mode). You can also set an ROI if you want even faster fps rate.

Below are the maximum speeds of ASI585 running at different ADC modes.

Resolution	USB 3.0			USB 2.0		
	12BIT ADC		10BIT ADC	12BIT ADC		10BIT ADC
	RAW16	RAW8	RAW8	RAW16	RAW8	RAW8
3840*2160	23.7	46.9	46.9	2.61	5.2	5.2
1920*1080	91.4	91.4	91.4	10.4	20.8	20.8
1280*720	133.5	133.5	133.5	23.5	47	47
640*480	192.9	192.9	192.9	70.5	141.3	141.3
320*240	347.3	347.3	347.3	283.1	347.3	347.3

## 6.6 Binning

ASI585 camera supports software bin2, bin3 and bin4 mode and hardware bin2, bin3 and bin4 mode.

The biggest benefit is a faster frame rate. If you don't care about speed, we suggest you use software binning.

## 7. How to use your camera

There are many adapters available for this camera for connecting to your scope or lens. Some are included with the camera and others you can order from our site:

<https://astronomy-imaging-camera.com>

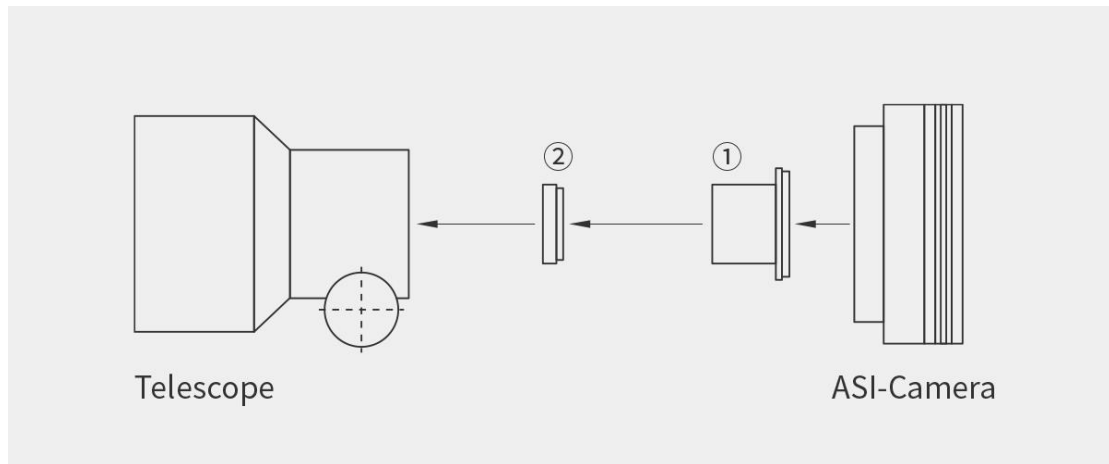

- ① 1.25" Nosepiece
- ② 1.25" filter (optional)



## Notice for use

Below are the requirements for camera storage and working temperature. Please don't use your camera when the environment does not meet these requirements, otherwise the camera might get damaged.

Working temperature	-5°C ~ 50°C
Working humidity	20% ~ 80%
Storage temperature	-20°C ~ 60°C
Storage humidity	20% ~ 95%

Do not use corrosive solutions to clean the camera, so as not to corrode the surface oxide layer and not to damage the camera; Meanwhile, do not expose the camera to the sun for a long time, so as not to discolor the appearance of the oxide layer.

## 8. Cleaning

The camera is sealed and comes with an AR protect window to protect the sensor from dusts and humidity.

To see the dusts, you just need to set up your telescope and point it to a bright place. A Barlow is required to see these dusts clearly. Then attach the camera and adjust the exposure to make sure not overly exposed. You can see an image like below if it's dirty.

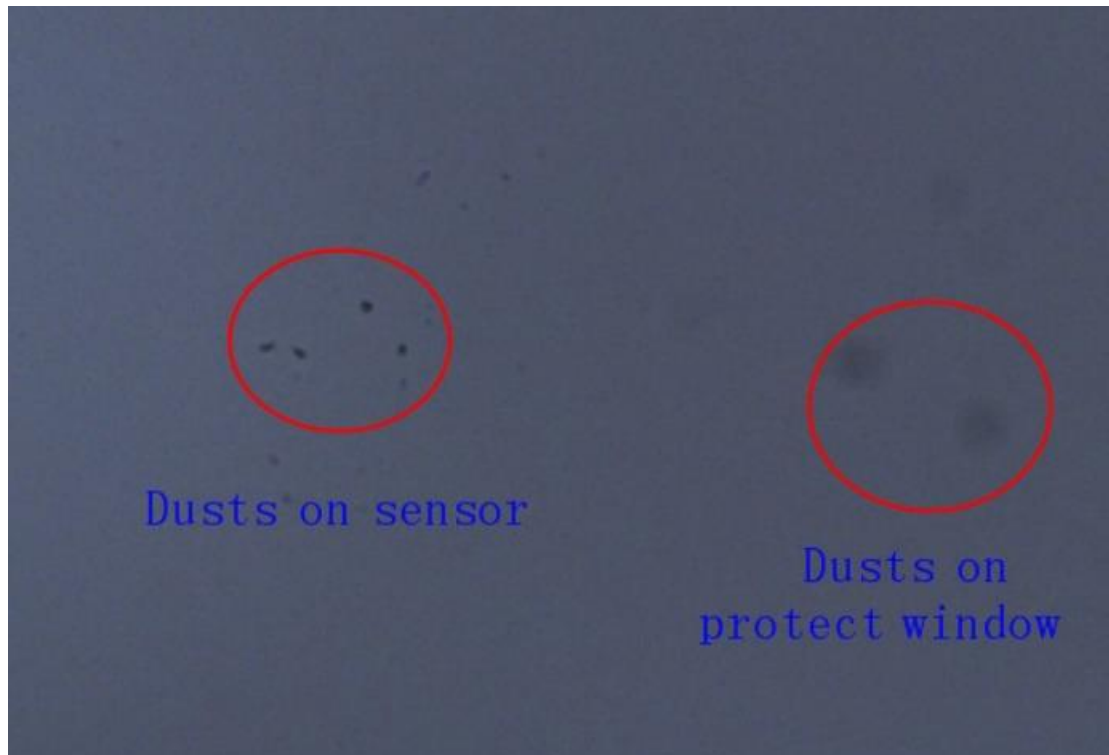

The big dim spot on the image (right side) are the shadows of dust on the protect window.

The very small but very dark spot on the image (at left) are the shadows of the dusts on the sensor.

If above situation occurs, it is recommended that the dust on the sensor surface be blown off with air pump. If it cannot be blown off, it is recommended to use cotton swabs and 99% anhydrous ethanol to gently wipe the sensor.

We have very detailed instruction on our website:

[https://astronomy-imaging-camera.com/manuals/How\\_to\\_clean\\_ASI\\_camera\\_and\\_redry\\_the\\_desiccant.pdf](https://astronomy-imaging-camera.com/manuals/How_to_clean_ASI_camera_and_redry_the_desiccant.pdf)

## 9. Warranty

1. ZWO will provide a 2-year free warranty service (Warranty Period) for ZWO products purchased by Users from ZWO (“Products”) in accordance with this Policy, commencing on the day following receipt of the Products by Users. For ASIAIR Plus users, commencing on the day of device activation.

2. If a User encounters the following Dead on Arrival (DOA) and contacts ZWO within the corresponding time limit to issue the Product purchase invoice and relevant evidence, ZWO will provide door-to-door pick-up service and, as appropriate, after-sale replacement (or partial replacement), repair or return (or partial return) service for the following Products:

1) Product quality problem

Provided that a User detects a quality problem and contacts ZWO within 30 days after receipt of the Products, and ZWO support team confirms that the Products indeed have a quality problem or defect after their inspection, ZWO will provide free replacement service towards such Products;

2) Product transportation problem

Provided that a User finds obvious signs of bubbling, serious overstocking, or deformation on the outer package of the Products upon receipt of the Products, and provides ZWO with pictures of the outer package and proof of receipt within 3 days after receipt of such Products, ZWO support team will verify the actual shipper and determine the responsible party for such transportation problem. In the event that ZWO is the actual shipper, ZWO will be responsible for providing the relevant return or replacement service, however, if the Products are directly sold or transported to the User by an agent of ZWO, the agent will be responsible for providing the relevant return or replacement service.

3. If the Products are under the following circumstances, they are not within the scope of warranty service, ZWO may provide maintenance services to the Users:

1) The Warranty Period of the Products has expired; or

2) The Products are injected into liquid or affected by moisture or corrosion; or

3) The Products are damaged by an external force (such as the broken of the camera protection window glass, the deformation of the product shell, the broken of the USB port, etc.); or

4) Disassembling, repairing by a third party, refurbishment of the Products (such as downloading erroneous firmware) without the written authorization of ZWO; or

5) The product system is modified, or the maintenance notice is lost or changed; or

6) Product quality problem caused by installation not following the requirements or instructions for the Products; or

7) Physical damage or failure of the Products caused by the force majeure (such as strong vibration or extrusion such as flood, fire, earthquake, or thunder stroke); or

8) Damage caused by the improper User operation during the period of shooting or use, such as using without the equipment protection or direct shooting of the sun; or

9) No valid purchase invoice or warranty certificate; or

10) The Products are second-hand products.



Any quality problem with the accessories or other parts of the Products is not a condition for the return or change of the Products, and the User may solely request to replace the accessories with new ones, which shall be handled after verification by ZWO support team.

If the issue with your ZWO product was caused by certain damage (such as severe damage not covered by the 2-year warranty), you might have to pay the replacement value.

## 10. Servicing

For software upgrades, please refer to “Support-manual and software” on our official website.

<https://astronomy-imaging-camera.com/>

For repairs and consultation, you can visit here: <https://support.astronomy-imaging-camera.com/>

Note:

1. For the normal repair or replacement of the Products during the Warranty Period, the User will bear the return cost. When returning the Products, Users shall specify the actual reasons for the damage to the Products, and shall provide the corresponding valid certificates, such as pictures or videos, etc.

For the Products that need to be replaced after being confirmed by ZWO in writing, the User shall return the Products with the complete package, together with all accessories, manuals, etc., to the address designated by ZWO.

By sending back the product to ZWO, the User agrees to pay out-of-warranty fees that may arise during the repair process of the product. ZWO will send back the product after charging.

2. For the Products that need to be returned for after-sales service, ZWO will provide the corresponding RMA code for reference.

ZWO will not accept any products having no RMA code that have been returned privately without ZWO written confirmation.

3. If a User purchases the ZWO Products from a ZWO agent, the User may contact the ZWO agent directly for the relevant after-sales service.